

WIKĘD



19

**EXTERIOR
DOORS**

**27 YEARS
WITH YOU**

INTRODUCTION	04
ABOUT US	06
NEW: ALU HYBRID	08
COLLECTION GLASS	014
COLLECTION FUTURE	028
COLLECTION CLASSIC	038
DOOR CONSTRUCTION AND TECHNOLOGY	057
ACCESSORIES	065
COLORS	066
GLASS OPTIONS	072
COLLECTION MY GLASS	080
DOOR BARS	082
HANDLES	094
SIDELIGHTS	102
LED LIGHTING	103

INTRODUCTION

WIKĘD is a Polish manufacturer of windows and exterior doors for houses and apartments. In a factory located in Luzino in northern Poland there are currently over 400 employees.

The brand was founded in 2002 and in for two decades now constantly improves its products.

WIKĘD is the leader in the exterior doors market in Poland, receiving numerous awards and distinctions in rankings.





MODEL 48 / DOOR BAR TORO / WOODEC OAK TURNER / DEERSTONE FRAME FOR GLASS

ABOUT US

Our doors open millions of homes

WIKĘD gives you unlimited possibilities of choosing and personalizing the door for your home. The unique variety and the multitude of possibilities for new solutions will emphasize the individual style. We use proven technologies for the production of our doors, which, combined with a modern machine park, allows us to produce doors for the most demanding customers.

modern
machine park

proven
technologies



NEW
2022

TECHNOLOGY

ALU HYBRID

The flush-mounted seamless ALU HYBRID door is a combination of two proven technologies used so far in the WIKĘD door - a reliable, warm and slender aluminum frame and a super-durable glass fiber composite with a carbon coating with excellent thermal and static parameters, which is the core of the door. The new technology allows you to create doors that are flush on both sides with a door-leaf made of two aluminum sheets which combined creates the highest product class.



**ALU
HYBRID**

The combination of aluminum technology and carbon structured fiberglass allows to achieve an effect of a door-leaf flush on both sides. The new design composed with the most demanding tastes in mind, perfectly matches the current architectural trends.

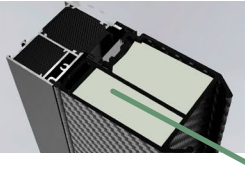

HYBRID OF ALUMINUM FRAME
AND CARBON STRUCTURED
FIBER GLASS COMPOSITE



HEAT TRANSMITTANCE COEFFICIENT
 $U_d=0,54 \text{ W/m}^2\text{K}$



3D ADJUSTABLE HIDDEN HINGES



BOTH SIDES FLUSH MOUNTED

8-POINT LOCKING MECHANISM



TECHNOLOGY
ALU HYBRID







GLASS
DESIGN

The Black glazing in the Glass Design door collection is very reflective. The presented doors feature full-height glass, which gave this unique visual effect.

COLLECTION

GLASS DESIGN

GLASS DESIGN exterior doors are a very attractive proposition of a modern, refined design.

This collection is distinguished by exceptional attention to every detail. Door leaf and the glass pane form a uniform plane from the outside as well as inside of the house.

GLASS DESIGN



Model GD04

CRYSTAL SKY COLOR
DARK MINT
GLASS
BLACK
DOOR-BAR
BETA

2022
2022
2022
NEW NEW
NEW NEW
NEW NEW
NEW NEW



Model GD01a

CRYSTAL SKY COLOR
MAGNOLIA BLOSSOM
GLASS
BLACK
DOOR-BAR
POCKET



Model GD01b

NATURAL DECOR
WOODEC OAK TURNER
GLASS
BLACK
DOOR-BAR
BETA



Model GD01c

NATURAL DECOR
WOODEC OAK TURNER
GLASS
BLACK
DOOR-BAR
STRIPE



Model GD02a

NATURAL DECOR
WOODEC OAK TURNER
GLASS
BLACK
DOOR-BAR
BETA



Model GD02b

HARMONY COLOR
RAL 6021
GLASS
BLACK
DOOR-BAR
BETA



Model GD03a

NATURAL DECOR
WOODEC OAK TURNER
GLASS
BLACK
DOOR-BAR
BETA



GLASS
LOFT

The GLASS LOFT collection is a perfect example of the possibility of combining the Black glass along the entire height of the door leaf with the latest model of this collection and with an individual color.

COLLECTION GLASSLOFT

Exterior doors from the GLASS LOFT collection fascinate with the panes of glass applied directly on the door leaf with a built-in glazing unit. Under the black, Lacobel glass we placed translucent glass.

GLASS LOFT



Model GL01

NATURAL DECOR
SILVER-GREY
GLASS
BLACK
DOOR-BAR
POCKET



Model GL01a

CRYSTAL SKY COLOR
LIMESTONE
GLASS
BLACK
HANDLE
MANITOBA



Model GL02

NATURAL DECOR
WOODEC OAK TURNER
GLASS
BLACK
DOOR-BAR
BETA



Model GL02a

CRYSTAL SKY COLOR
MAGNOLIA BLOSSOM
GLASS
BLACK
DOOR-BAR
DUO BLACK

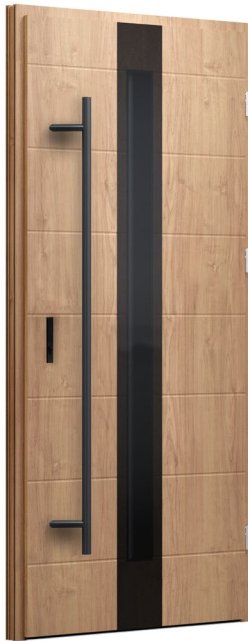

Model GL02b

NATURAL DECOR
WINCHESTER
GLASS
BLACK
DOOR-BAR
ALFA



Model GL02C

NATURAL DECOR
WHITE MATT
GLASS
BLACK
HANDLE
MANITOBA



Model GL03

NATURAL DECOR
ANTHRACITE PLAIN
GLASS
BLACK
DOOR-BAR
TORO



Model GL03a

NATURAL DECOR
BLEACHED OAK
GLASS
BLACK
HANDLE
MAGNUS



Model GL03b

NATURAL DECOR
WINCHESTER
GLASS
BLACK
DOOR-BAR
DUO BLACK



Model GL03c

NATURAL DECOR
BLACK MATT
GLASS
BLACK
HANDLE
TAHOMA



GLASS FRONT

The GLASS FRONT collection has been expanded with two original designs, with an interestingly placed glass pane on the surface. For the first time, we installed the Alfa DOOR-BAR to adjust it to individuality in design.

COLLECTION GLASSFRONT

GLASS FRONT exterior doors collection is distinguished by a deeply black glass pane. Black glass is applied directly onto the full door leaf giving a realistic glazing effect.

GLASS FRONT



2022
2022
2022
NEW NEW
NEW NEW
NEW NEW
NEW NEW

Model GF06

CRYSTAL SKY COLOR
RUSTY BRONZE
DECOR
LACOBEL
DOOR-BAR
POCKET WITH GLASS



2022
2022
2022
NEW NEW
NEW NEW
NEW NEW
NEW NEW

Model GF07

NATURAL DECOR
ANTHRACITE PLAIN
DECOR
LACOBEL
DOOR-BAR
ALFA



Model GF01

NATURAL DECOR
SILVER-GREY
DECOR
LACOBEL
DOOR-BAR
POCKET



Model GF01a

CRYSTAL SKY COLOR
MAGNOLIA BLOSSOM
DECOR
LACOBEL
DOOR-BAR
ALFA

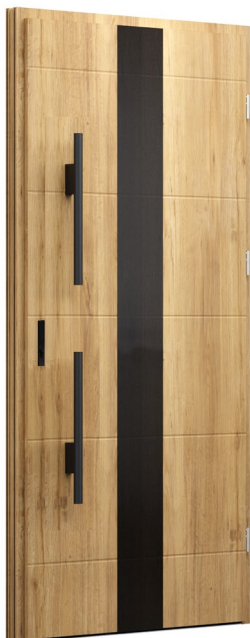

Model GF02

NATURAL DECOR
WOODEC OAK TURNER
DECOR
LACOBEL
DOOR-BAR
DUO BLACK



Model GF02a

CRYSTAL SKY COLOR
LIMESTONE
DECOR
LACOBEL
DOOR-BAR
ALFA



Model GF02b

NATURAL DECOR
WINCHESTER
DECOR
LACOBEL
HANDLE
PRESTIGE



Model GF02c

NATURAL DECOR
WINCHESTER
DECOR
LACOBEL
HANDLE
TAHOMA



Model GF03

NATURAL DECOR
WALNUT
DECOR
LACOBEL
DOOR-BAR
STRIPE



Model GF03a

NATURAL DECOR
WHITE MATT
DECOR
LACOBEL
DOOR-BAR
ALFA



Model GF03b

NATURAL DECOR
BLACK MATT
DECOR
LACOBEL
DOOR-BAR
TORO



Model GF03c

CRYSTAL SKY COLOR
RUSTY BRONZE
DECOR
LACOBEL
DOOR-BAR
ALFA



Model GF04

NATURAL DECOR
WOODEC OAK TURNER
DECOR
LACOBEL
DOOR-BAR
TORO



Model GF05

HARMONY COLOR
RAL 6021
DECOR
LACOBEL
DOOR-BAR
STRIPE



MODEL GF06 / COLOR SILVER-GREY / DOOR-BAR SLIM POCKET



Future
INOX

Door leaf coat and decorative elements from the Future INOX collection are made entirely of aluminum.

Through this doors are exceptionally durable and feature very good protection against weather conditions.

MODEL FI11 / COLOR WINCHESTER / DOOR-BAR TORO / SIDELIGHT WITH ONE WAY MIRROR

COLLECTION

FutureINOX

FUTURE INOX aluminum doors are completely smooth. Glazing and decorative aluminum frames are fitted perfectly with the door surface. These details reflect the whole idea of the Future INOX collection.

INOX Future



2022
2022
2022
NEW NEW
NEW NEW
NEW NEW
NEW NEW

Model FI11

NATURAL DECOR
SILK ANTHRACITE
GLASS
SATIN
DECOR
INOX
DOOR-BAR
TORO



2022
2022
2022
NEW NEW
NEW NEW
NEW NEW
NEW NEW

Model FI12

NATURAL DECOR
WOODEC OAK TURNER
DOOR-BAR
POCKET



2022
2022
2022
2022
NEW NEW
NEW NEW
NEW NEW
NEW NEW

Model FI13

NATURAL DECOR
WOODEC OAK TURNER
DECOR
BLACK
DOOR-BAR
POCKET



2022
2022
2022
2022
NEW NEW
NEW NEW
NEW NEW
NEW NEW

Model FI14

NATURAL DECOR
WOODEC OAK TURNER
DECOR
BLACK
HANDLE
TAHOMA



Model FI01a

NATURAL DECOR
WHITE MATT

DECOR
INOX
HANDLE
ALFA



Model FI01b

NATURAL DECOR
SILVER-GREY

DECOR
INOX
HANDLE
MANITOBA



Model FI01c

NATURAL DECOR
WOODDEC OAK TURNER

DECOR
INOX
HANDLE
MANITOBA



Model FI01d

NATURAL DECOR
ANTHRACITE PLAIN

DECOR
INOX
HANDLE
MANITOBA



Model FI02a

NATURAL DECOR
WALNUT

DECOR
INOX
DOOR-BAR
TORO



Model FI02b

NATURAL DECOR
WHITE MATT

DECOR
INOX
HANDLE
MANITOBA



Model FI03a

NATURAL DECOR
Anthracite PLAIN
DECOR
INOX
HANDLE
MANITOBA



Model FI03b

NATURAL DECOR
SILK ANTHRACITE
DECOR
INOX
HANDLE
MANITOBA



Model FI04a

NATURAL DECOR
BLACK MATT
GLASS
STANDARD
DECOR
INOX
DOOR-BAR
TORO



Model FI04b

NATURAL DECOR
ANTHRACITE PLAIN
GLASS
STANDARD
DECOR
BLACK
DOOR-BAR
ALFA



Model FI04c

NATURAL DECOR
WALNUT
GLASS
STANDARD
DECOR
BLACK
DOOR-BAR
TORO



Model FI04d

NATURAL DECOR
ANTHRACITE PLAIN
PRZESZKLENIE
STANDARD
DECOR
BLACK
DOOR-BAR
BETA



Model FI04e

NATURAL DECOR
SILVER-GREY
GLASS
STANDARD
DECOR
BLACK
DOOR-BAR
ALFA



Model FI05a

NATURAL DECOR
ANTHRACITE PLAIN
GLASS
STANDARD
DECOR
INOX
DOOR-BAR
DUO BLACK



Model FI05b

NATURAL DECOR
WHITE MATT
GLASS
STANDARD
DECOR
INOX
HANDLE
MANITOBA



Model FI05c

NATURAL DECOR
WOODEC OAK TURNER
GLASS
STANDARD
DECOR
INOX
DOOR-BAR
BETA



Model FI05d

NATURAL DECOR
ANTHRACITE PLAIN
GLASS
STANDARD
DECOR
INOX
HANDLE
TAHOMA



Model FI05e

NATURAL DECOR
BLACK MATT
GLASS
STANDARD
DECOR
INOX
HANDLE
TAHOMA



Model FI06a

NATURAL DECOR
ANTHRACITE PLAIN
GLASS
STANDARD
DECOR
INOX
DOOR-BAR
POCKET



Model FI06b

NATURAL DECOR
SILVER-GREY
GLASS
STANDARD
DECOR
INOX
DOOR-BAR
ALFA



Model FI06c

NATURAL DECOR
WOODEC OAK TURNER
GLASS
STANDARD
DECOR
INOX
DOOR-BAR
POCKET



Model FI06d

NATURAL DECOR
WHITE MATT
GLASS
STANDARD
DECOR
INOX
DOOR-BAR
ALFA



Model FI06e

NATURAL DECOR
SILVER-GREY
GLASS
SATIN
DECOR
INOX
DOOR-BAR
ALFA



Model

NATURAL DECOR
SILK ANTHRACITE
PRZESZKLENIE
SATIN
DECOR
INOX
DOOR-BAR
DUO BLACK



Model FI07b

NATURAL DECOR
WODEC OAK TURNER
GLASS
SATIN
DECOR
INOX
DOOR-BAR
BETA



Model FI07c

NATURAL DECOR
WHITE MATT
GLASS
SATIN
DECOR
INOX
DOOR-BAR
BETA



Model FI07d

NATURAL DECOR
WALNUT
GLASS
SATIN
DECOR
INOX
DOOR-BAR
ALFA



Model FI07e

NATURAL DECOR
WINCHESTER
GLASS
SATIN
DECOR
INOX
DOOR-BAR
ALFA



Model FI08a

NATURAL DECOR
WODEC OAK TOFFEE
GLASS
SATIN
DECOR
BLACK
DOOR-BAR
SPACE LACOBEL



Model FI08b

NATURAL DECOR
SILVER-GREY
GLASS
SATIN
DECOR
INOX
DOOR-BAR
BETA



Model FI09a

NATURAL DECOR
WHITE MATT
GLASS
SATIN
DECOR
INOX
DOOR-BAR
ALFA



Model FI09b

NATURAL DECOR
BLACK MATT
GLASS
STANDARD
DECOR
INOX
DOOR-BAR
ALFA



Model FI09c

NATURAL DECOR
WOODEC OAK TURNER
GLASS
STANDARD
DECOR
INOX
HANDLE
MAGNUS



Model FI10a

NATURAL DECOR
WINCHESTER
GLASS
STANDARD
DECOR
INOX
DOOR-BAR
ALFA



Model FI10b

NATURAL DECOR
ANTHRACITE PLAIN
GLASS
STANDARD
DECOR
INOX
DOOR-BAR
TORO



MODEL F112 / COLOR WOOD ECG OAK TURNER / DOOR BAR ROCKET



The unique variety of classic WIKĘD external doors gives practically unlimited possibilities, options and variation of personalization. Create the perfect solution for yourself using our configurator available on website www.wiked.pl

COLLECTION

Classic Models

Classic doors can be divided into two types: the former, comprised of models with lower numbering will work great in classic construction, where elegance and timelessness are the most valued style. The latter are characterized by simplicity in shapes, these are the doors for lovers of simple, modern and functional style.



CLIENTS' CHOICE
CLIENTS' CHOICE
CLIENTS' CHOICE

Model 1

HARMONY COLOR
RAL 6021
DOOR-BAR
POCKET



2022
2022
2022
NEW NEW
NEW NEW
NEW NEW

Model 51

CRYSTAL SKY COLOR
COBALT BLUE
NATURAL DECOR
BLACK MATT
DOOR-BAR
TORO



2022
2022
2022
NEW NEW
NEW NEW
NEW NEW

Model 52

CRYSTAL SKY COLOR
MAGNOLIA BLOSSOM
NATURAL DECOR
DARK BRONZE
DOOR-BAR
BETA



Model 13

NATURAL DECOR
WALNUT
DOOR-BAR
BETA



Model 14

CRYSTAL SKY COLOR
DARK MINT
DOOR-BAR
ALFA



Model 26c

CRYSTAL SKY COLOR
LIMESTONE
HANDLE
TAHOMA

NO GLASS, NO DECORATIVE FRAMES



Model 26d

NATURAL DECOR
WODEC OAK TURNER
DOOR-BAR
TORO



Model 26e

NATURAL DECOR
WALNUT
DOOR-BAR
STRIPE



Model 26f

NATURAL DECOR
WHITE MATT
DOOR-BAR
ALFA



Model 26g

NATURAL DECOR
SILVER-GREY
DOOR-BAR
STRIPE



Model 26i

CRYSTAL SKY COLOR
COBALT BLUE
DOOR-BAR
TORO



Model 27

NATURAL DECOR
WALNUT
DOOR-BAR
BETA



Model 28

NATURAL DECOR
WALNUT
HANDLE
MANITOBA



Model 43

NATURAL DECOR
BLEACHED OAK
DOOR-BAR
TORO



Model 43a

NATURAL DECOR
BLACK MATT
DOOR-BAR
SPACE



Model 43b

NATURAL DECOR
WOODDEC OAK TURNER
DOOR-BAR
DUO BLACK



Model 43c

NATURAL DECOR
ANTHRACITE PLAIN
HANDLE
TAHOMA

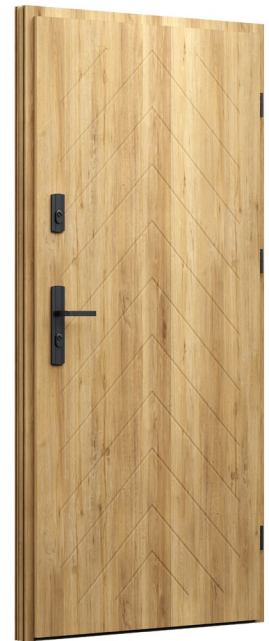

Model 49

NATURAL DECOR
WOODDEC OAK TURNER
HANDLE
PRESTIGE C



Model 32

HARMONY COLOR
RAL 6021
DECOR
INOX
DOOR-BAR
TORO



Model 32a

CRYSTAL SKY COLOR
BASALT WHITE
DECOR
INOX
DOOR-BAR
BETA



Model 32b

CRYSTAL SKY COLOR
MAGNOLIA BLOSSOM
DECOR
INOX
DOOR-BAR
POCKET



Model 40

NATURAL DECOR
BLEACHED OAK
DECOR
INOX
HANDLE
MAGNUS



Model 40a

NATURAL DECOR
WALNUT
DECOR
INOX
HANDLE
TAHOMA



Model 41

NATURAL DECOR
WINCHESTER
DECOR
INOX
HANDLE
STRIPE



Model 41a

CRYSTAL SKY COLOR
DARK MINT
DECOR
INOX
DOOR-BAR
BETA



Model 41b

NATURAL DECOR
WINCHESTER
DECOR
INOX
DOOR-BAR
TORO



Model 44

Natural DECOR
WINCHESTER
DECOR
BLACK
HANDLE
TAHOMA



Model 44a

NATURAL DECOR
ANTHRACITE PLAIN
DECOR
INOX
HANDLE
TAHOMA



Model 44b

NATURAL DECOR
WOODEC OAK TURNER
DECOR
BLACK
HANDLE
TAHOMA



Model 44c

CRYSTAL SKY COLOR
MEDIUM GREY
DECOR
INOX
HANDLE
TAHOMA



Model 45

NATURAL DECOR
WOODEC OAK TURNER
DECOR
DEERSTONE
DOOR-BAR
STRIPE



Model 45a

CRYSTAL SKY COLOR
LIMESTONE
DECOR
BLACK
HANDLE
MANITOBA



Model 45b

NATURAL DECOR
BLEACHED OAK
DECOR
BLACK
HANDLE
MANITOBA



Model 46

CRYSTAL SKY COLOR
DARK BRONZE
DECOR
DEERSTONE
HANDLE
TAHOMA



Model 46a

NATURAL DECOR
WINCHESTER
DECOR
INOX
HANDLE
TAHOMA



Model 46b

CRYSTAL SKY COLOR
COBALT BLUE
DECOR
BLACK
HANDLE
TAHOMA



Model 26j

NATURAL DECOR
WOODEC OAK TURNER
DECOR
BLACK
DOOR-BAR
SPACE



Model 26k

NATURAL DECOR
WOODEC OAK TURNER
DECOR
INOX
DOOR-BAR
TORO



Model 39

CRYSTAL SKY COLOR
CARBON
GLASS
SATIN
DECOR
INOX
DOOR-BAR
SPACE



Model 39a

CRYSTAL SKY COLOR
MEDIUM GREY
GLASS
STANDARD
DECOR
INOX
DOOR-BAR
TORO



Model 39b

CRYSTAL SKY COLOR
MAGNOLIA BLOSSOM
GLASS
STANDARD
DECOR
INOX
DOOR-BAR
BETA



Model 2

NATURAL DECOR
TOFFEE
GLASS
SATIN LEAF
HANDLE
PRESTIGE C



Model 3

NATURAL DECOR
WINCHESTER
GLASS
SATIN LEAF
DOOR-BAR
ALFA



Model 4

GLASS
DIAMONT
HANDLE
MANITOBA



Model 5

NATURAL DECOR
BLEACHED OAK
GLASS
DIAMONT
DOOR-BAR
ALFA



Model 8

NATURAL DECOR
WALNUT
GLASS
SATIN
HANDLE
PRIME



Model 9

NATURAL DECOR
ANTHRACITE PLAIN
GLASS
SATIN
DOOR-BAR
ALFA



Model 9a

NATURAL DECOR
GOLDEN OAK
GLASS
STANDARD
HANDLE
PRESTIGE



Model 9b

NATURAL DECOR
GOLDEN OAK
GLASS
STANDARD
HANDLE
PRESTIGE



Model 34

NATURAL DECOR
WALNUT
GLASS
SATIN
HANDLE
MANITOBA



Model 34a

NATURAL DECOR
WHITE MATT
GLASS
STANDARD
HANDLE
MANITOBA

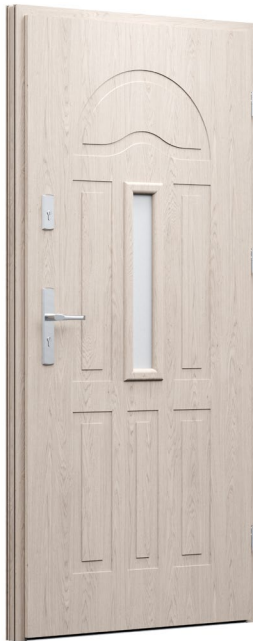

Model 34b

NATURAL DECOR
BLEACHED OAK
GLASS
SATIN
HANDLE
MANITOBA



Model 21

Natural DECOR
BLEACHED OAK
GLASS
SANDBLASTED
DECOR
INOX
DOOR-BAR
BETA



Model 21a

NATURAL DECOR
Walnut
GLASS
SATIN
DECOR
INOX
DOOR-BAR
BETA



Model 22

CRYSTAL SKY COLOR
BASALT WHITE
GLASS
SATIN
DECOR
INOX
DOOR-BAR
TORO



Model 22a

HARMONY COLOR
RAL 6021
GLASS
SATIN
DECOR
INOX
DOOR-BAR
DUO BLACK



Model 22b

CRYSTAL SKY COLOR
RUSTY BRONZE
GLASS
SATIN
DECOR
INOX
DOOR-BAR
ALFA



Model 23

NATURAL DECOR
BLACK MATT
GLASS
SATIN
Decor
INOX
HANDLE
MANITOBA



Model 23a

CRYSTAL SKY COLOR
RUSTY BRONZE
GLASS
SATIN
DECOR
INOX
HANDLE
MANITOBA



Model 24

NATURAL DECOR
ANTHRACITE PLAIN
GLASS
SATIN
DECOR
INOX
DOOR-BAR
DUO BLACK



Model 31

NATURAL DECOR
WHITE MATT
GLASS
SATIN
DECOR
INOX
DOOR-BAR
ALFA



Model 31a

NATURAL DECOR
SILVER-GREY
GLASS
SATIN
DECOR
INOX
DOOR-BAR
ALFA



Model 36

NATURAL DECOR
WALNUT
GLASS
SANDBLASTED
DECOR
INOX
HANDLE
MANITOBA



Model 37

NATURAL DECOR
WOODEC OAK TURNER
GLASS
SATIN
DECOR
BLACK
DOOR-BAR
ALFA



Model 37a

CRYSTAL SKY COLOR
LIMESTONE
GLASS
SATIN
DECOR
BLACK
DOOR-BAR
TORO



Model 38

NATURAL DECOR
SILK ANTHRACITE
GLASS
SATIN
DECOR
INOX
DOOR-BAR
ALFA



Model 38a

CRYSTAL SKY COLOR
COBALT BLUE
GLASS
SATIN
DECOR
INOX
HANDLE
TAHOMA



2022
2022
2022
2022

NEW NEW
NEW NEW
NEW NEW
NEW NEW

Model 50

CRYSTAL SKY COLOR
RUSTY BRONZE
GLASS
SKIP BLACK LACOBEL
DECOR
BLACK
DOOR-BAR
BETA



Model 6

NATURAL DECOR
SILVER-GREY
GLASS
SATIN
DOOR-BAR
BETA



Model 12

NATURAL DECOR
BLEACHED OAK
GLASS
SANDBLASTED
DECOR
INOX
DOOR-BAR
BETA



Model 12a

CRYSTAL SKY COLOR
CARBON
GLASS
SATIN
DECOR
INOX
DOOR-BAR
BETA



Model 12b

Crystal SKY COLOR
COBALT BLUE
GLASS
SATIN
DECOR
BLACK
DOOR-BAR
DUO BLACK



Model 12c

NATURAL DECOR
WOODDEC OAK TURNER
GLASS
SANDBLASTED
Decor
INOX
DOOR-BAR
BETA



CLIENTS' CHOICE
CLIENTS' CHOICE
CLIENTS' CHOICE

Model 25

CRYSTAL SKY COLOR
DARK MINT
GLASS
STANDARD
DECOR
BLACK
DOOR-BAR
TORO



Model 25a

CRYSTAL SKY COLOR
MAGNOLIA BLOSSOM
GLASS
STANDARD
DECOR
BLACK
DOOR-BAR
ALFA



Model 25b

NATURAL DECOR
ANTHRACITE PLAIN
GLASS
STANDARD
DECOR
INOX
DOOR-BAR
TORO



Model 25c

NATURAL DECOR
WALNUT
GLASS
STANDARD
DECOR
DEERSTONE
HANDLE
MANITOBA



Model 26h

NATURAL DECOR
BLEACHED OAK
GLASS
STANDARD
DECOR
INOX
DOOR-BAR
BETA



Model 26

CRYSTAL SKY COLOR
RUSTY BRONZE
GLASS
STANDARD
DECOR
INOX
DOOR-BAR
BETA



Model 26a

NATURAL DECOR
ANTHRACITE PLAIN
GLASS
STANDARD
DECOR
INOX
DOOR-BAR
TORO



Model 26b

CRYSTAL SKY COLOR
MEDIUM GREY
GLASS
STANDARD
DECOR
INOX
DOOR-BAR
POCKET



Model 29

NATURAL DECOR
WHITE MATT
GLASS
STANDARD
DECOR
INOX
DOOR-BAR
SPACE

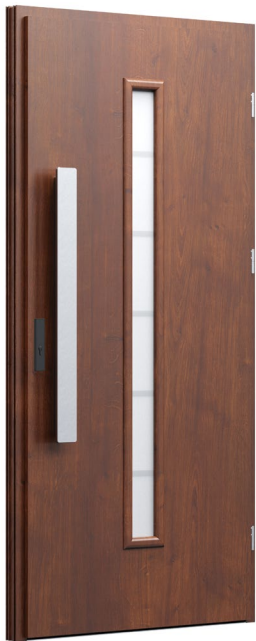

Model 29a

NATURAL DECOR
WALNUT
GLASS
SANDBLASTED
DOOR-BAR
SPACE



Model 30

CRYSTAL SKY COLOR
COBALT BLUE
GLASS
STANDARD
DECOR
DEERSTONE
DOOR-BAR
SPACE

CLIENTS' CHOICE
CLIENTS' CHOICE
CLIENTS' CHOICE



Model 30a

NATURAL DECOR
WOODDEC OAK TOFFEE
GLASS
STANDARD
DECOR
INOX
DOOR-BAR
ALFA



Model 30b

NATURAL DECOR
 ANTHRACITE PLAIN
GLASS
 STANDARD
DECOR
 INOX
DOOR-BAR
 ALFA



Model 42

NATURAL DECOR
 SILVER-GREY
GLASS
 STANDARD
DECOR
 PVC
DOOR-BAR
 ALFA



Model 47

NATURAL DECOR
 WOODEC OAK TURNER
GLASS
 LACOBEL BLACK
DECOR
 INOX
DOOR-BAR
 TORO



Model 48

CRYSTAL SKY COLOR
 RUSTY BRONZE
GLASS
 3D SKIP BLACK
DECOR
 BLACK
DOOR-BAR
 TORO





23

EXTERIOR DOORS

DOOR CONSTRUCTION AND TECHNOLOGY

ALU HYBRID

The flush-mounted seamless ALU HYBRID door is a combination of two proven technologies used so far in the WIKĘD door - a reliable, warm and slender aluminum frame and a super-durable glass fiber composite with a carbon coating with excellent thermal and static parameters, which is the core of the door. The new technology allows you to create doors that are flush on both sides with a door-leaf made of two aluminum sheets which combined creates the highest product class.



Heat transmittance coefficient
 $U_d=0,54 \text{ W/m}^2\text{K}^*$



Door leaf thickness



Acoustic isolation
30dB*



Security class RC2**



* Only doors without glazing

**IAW PN-EN 1627:2011. Only for full doors or with P4 glazing and INOX decor and fitted with C class lock and HANDLE

DOOR CONSTRUCTION

- ALU HYBRID insulated door frame with an XPS insert that improves thermal performance. **1**
- Door leaf made of fiberglass composite with carbon structure and filled with polyurethane foam with a composite frame. **2**
- Door leaf with peripheral seal and an additional masking trim. **3**
- Door leaf with peripheral seal and an additional masking trim.
- Three 3D hinges adjustable in 3 dimensions.
- 8-point locking mechanism (hook-bolts).
- Lower and upper points controlled with the main lock
- Clamping bar over the entire height of the of the frame.
- LAVA handles.
- Burglar-resistant cylinder-lock or double-sided cylinder (security class "D").
- Custom **WIKĘD** key.
- Minimalist ring door lock cover (with DOOR-BAR).
- Insulated PVC/ALU threshold with thermal partition. **4**

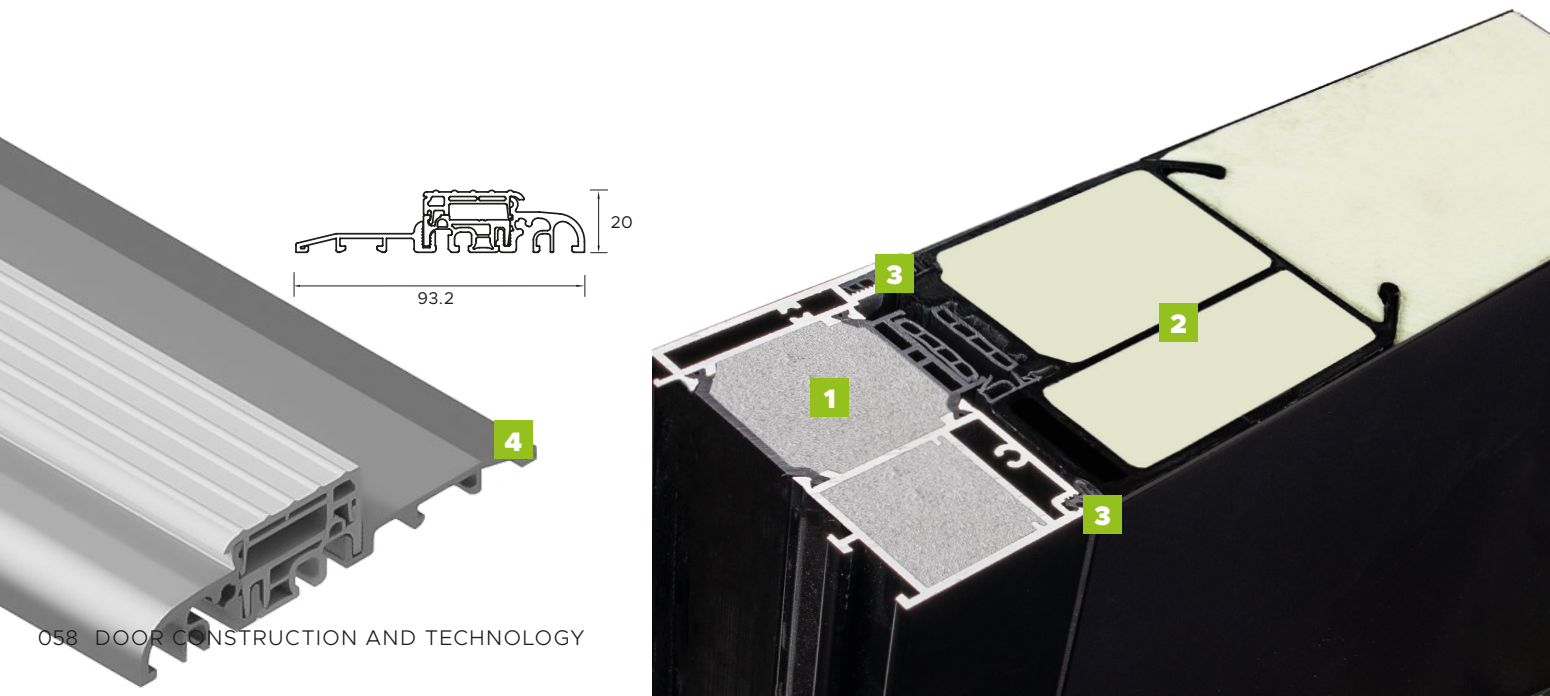
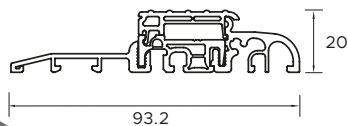

Termo Prestige Lux

A range of advanced entrance doors for very demanding customers. A wide choice of pattern configurations and accessories, combined with excellent technical parameters, guarantee perfect thermal and acoustic insulation values.



Heat transmittance coefficient
 $U_d=0,79 \text{ W/m}^2\text{K}^*$



Door leaf thickness



Acoustic isolation
32dB*



Security class RC2**



* Only doors without glazing

**IAW PN-EN 1627:2011. Only for full doors or with P4 glazing and INOX decor and fitted with C class lock and HANDLE

DOOR CONSTRUCTION

- Warm Termo Prestige frame with two seals and insulating filler in each chamber. **1**
- Door leaf with seal, filled with polyurethane foam and glued laminated timber frame. **2**
- 3 3D hinges adjustable in 3 dimensions. **3**
- Adjustable pressure for 3-point lock system.
- 6 anti-breach bolts.
- Key operated upper bolt with additional upper latch bolt.
- double cylinder lock or knob cylinder.
- 3-point lock with main lock and central latch bolt.
- Prime, Tahoma, Manitoba or Magnus HANDLE.
- Key operated lower bolt with additional lower latch bolt.
- Door leaf with 4-sided seal.
- Auto drop down seal.
- Windstoper (seal preventing potential drafts in threshold section).
- Warm, PVC/ALU threshold with thermal barrier. **4**

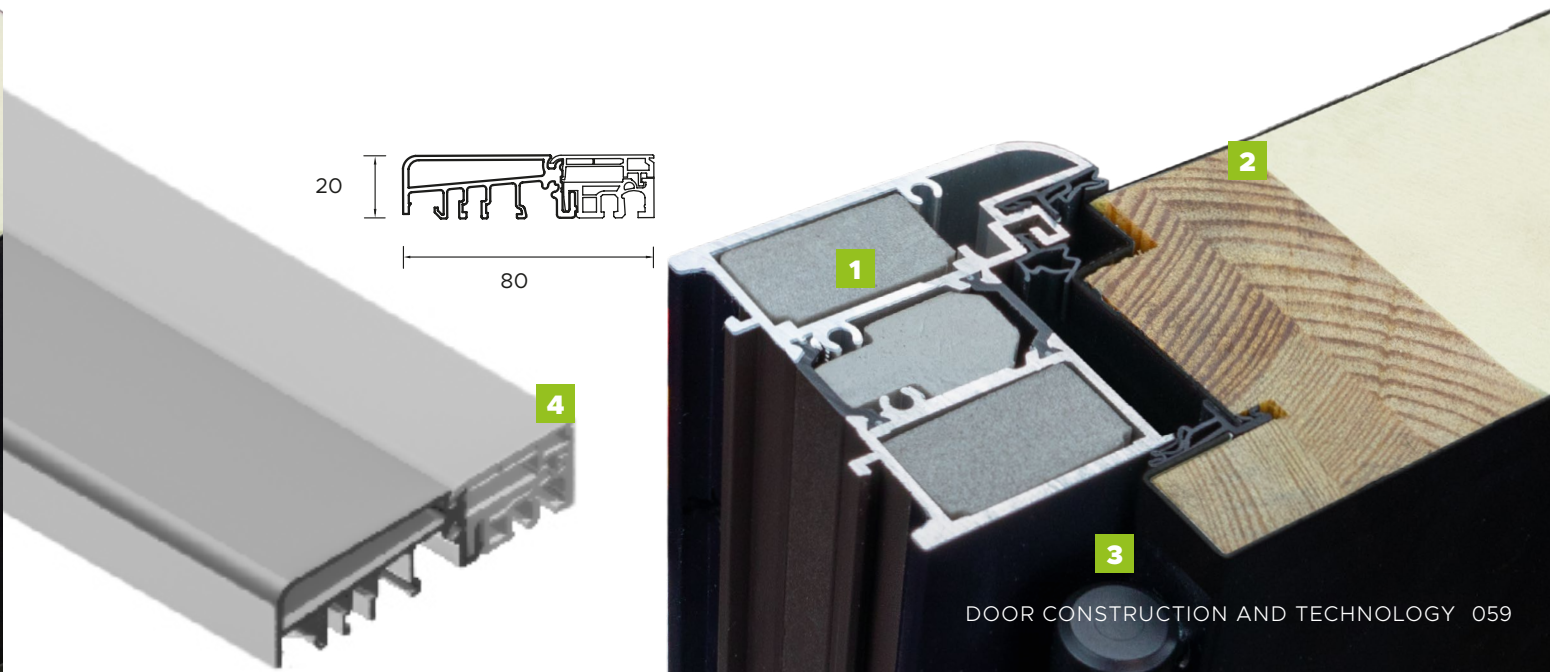
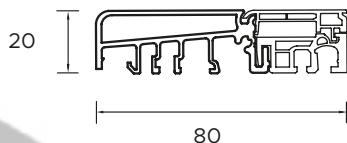

Optimum

The optimum range of entrance doors for demanding customers.
A wide range of visual and technical solutions combined with very good value for money.



Heat transmittance coefficient
 $U_d = 0,85 \text{ W/m}^2\text{K}^*$



Door leaf thickness



Acoustic isolation
32dB*



Security class RC2**



*Only doors without glazing

**IAW PN-EN 1627:2011. Only for full doors or with P4 glazing and INOX decor and fitted with C class lock and HANDLE

DOOR CONSTRUCTION

- - Warm Termo frame. **1**
- - Door leaf with seal, filled with polyurethane foam and glued laminated timber frame. **2**
- - 3 3D hinges adjustable in 3 dimensions. **3**
- - Adjustable pressure for 3-point lock system.
- - Adjustable latch.
- - 3 anti-breach bolts.
- - Upper hook-bolt.
- - Additional upper lock with knob cylinder (single key system).
- - 3-point lock with main lock and cylinder (single key system).
- - Prime, Tahoma, Manitoba or Magnus HANDLE.
- - Lower hook-bolt.
- - Door leaf with 4-sided seal.
- - Windstopper (seal preventing potential drafts in threshold section).
- - Warm, PVC/ALU threshold with thermal barrier. **4**

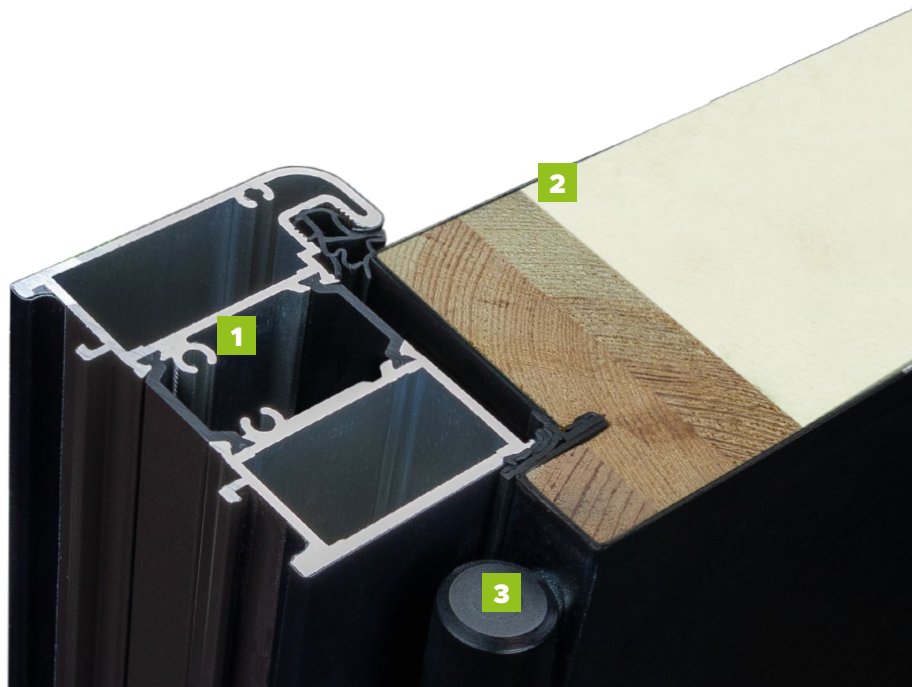
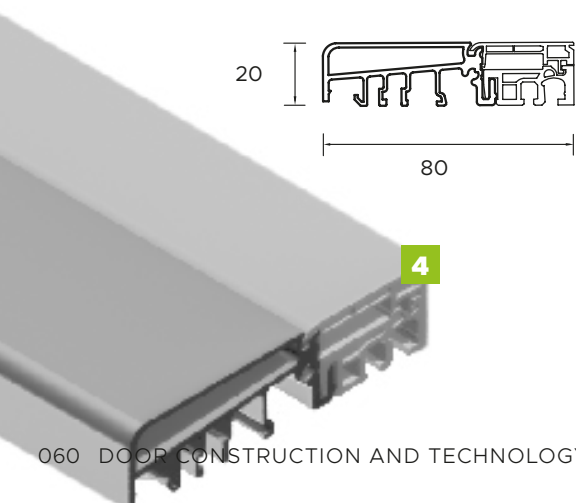
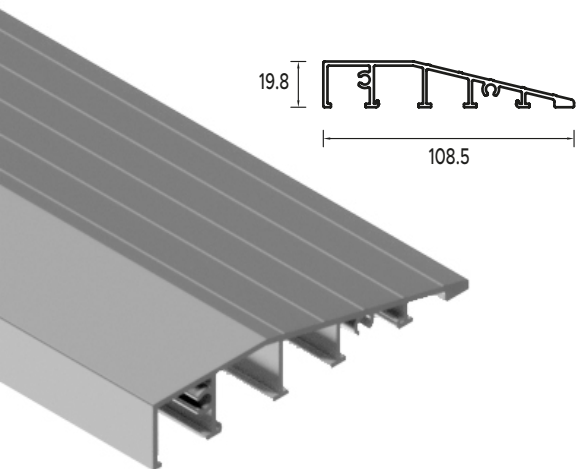

Premium

The basic range of entrance doors, good technical parameters.
Numerous models and equipment options combined with an attractive price.



Heat transmittance coefficient
 $U_d=0,98 \text{ W/m}^2\text{K}^*$



54 mm Door leaf thickness



Acoustic isolation
32dB*



Security class RC2**



* Only doors without glazing

**IAW PN-EN 1627:2011. Only for full doors or with P4 glazing and INOX decor and fitted with C class lock and HANDLE

DOOR CONSTRUCTION

- - Warm Termo frame (bought separately). **1**
- - Door leaf with seal, filled with polyurethane foam and glued laminated timber frame. **2**
- - 3 3D hinges adjustable in 3 dimensions. **3**
- - Decorative hinge caps.
- - Adjustable pressure for 3-point lock system.
- - Adjustable latch.
- - 3 anti-breach bolts.
- - Upper hook.
- - Additional upper lock with knob cylinder (single key system).
- - 3-point lock with main lock and cylinder (single key system).
- - Prime, Tahoma, Manitoba or Magnus HANDLE.
- - Lower hook.
- - Insulating brush.
- - PVC or ALU threshold with seal. **4**
- - Windstoper (seal preventing potential drafts in threshold section).

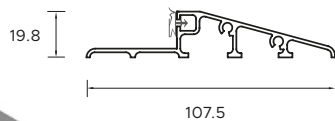

4

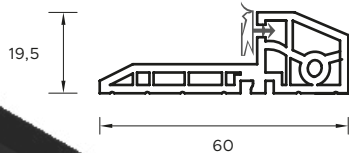

4

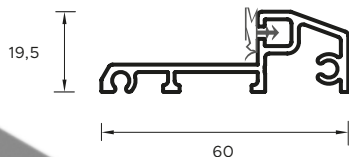

4

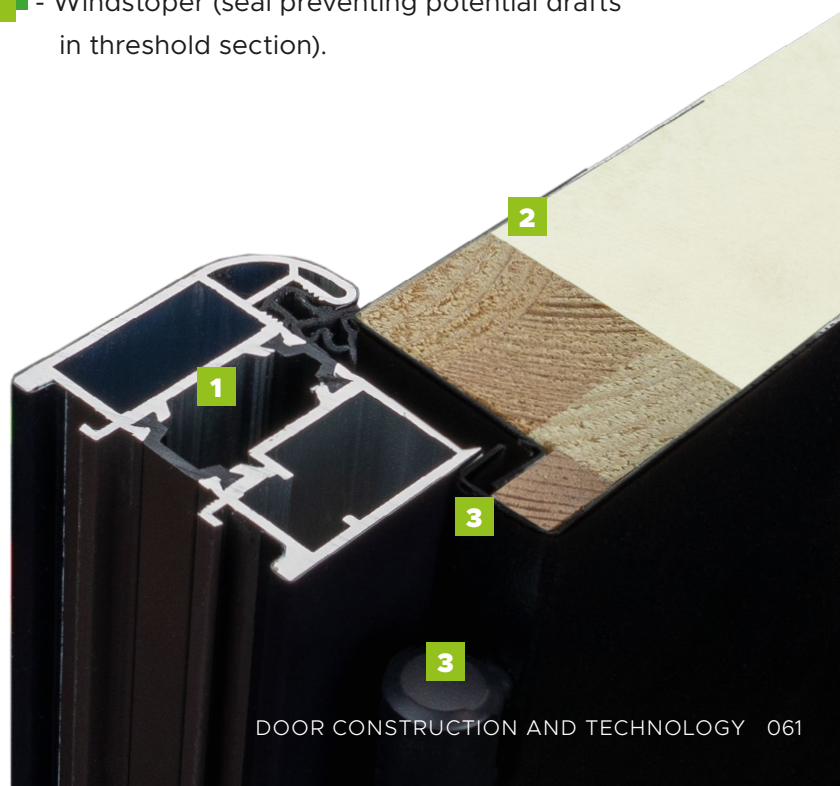



EXTERIOR DOORS
ACCESSORIES

COLORS

BASIC COLORS

NATURAL DECOR

UNIQUE LAMINATE WITH WOODEN STRUCTURES AND NEUTRAL SHADES.
THIS PALETTE CONTAINS STANDARD COLORS AND YOU CAN EASILY MATCH THESE WITH WINDOWS AND GARAGE DOORS.

CAMELEON COLORS

CRYSTAL SKY COLOR

UNIQUE DOOR PAINT COLORS WITH EXCEPTIONAL STRUCTURE OF CRYSTALS GLEAMING IN THE SUNLIGHT.
PREMIUM PALETTE INSPIRED BY VIBRANT GLOSSY CRYSTALS.

COLORS CAMELEON

HARMONY COLOR

COLORS FROM THE RAL PALETTE WITH A SUBTLE ORANGE SKIN STRUCTURE.
LET YOUR IMAGINATION LOOSE AND CHOOSE THE COLOR PERFECTLY FITTING THE CHARACTER OF YOUR HOME.

Entrance door from the Cameleon color range can be made as a solid door without millings, with millings and with glazing (only models with decorative frames in INOX or BLACK stainless steel and from the Glass Design range). The choice of Cameleon color is linked with extended production time.

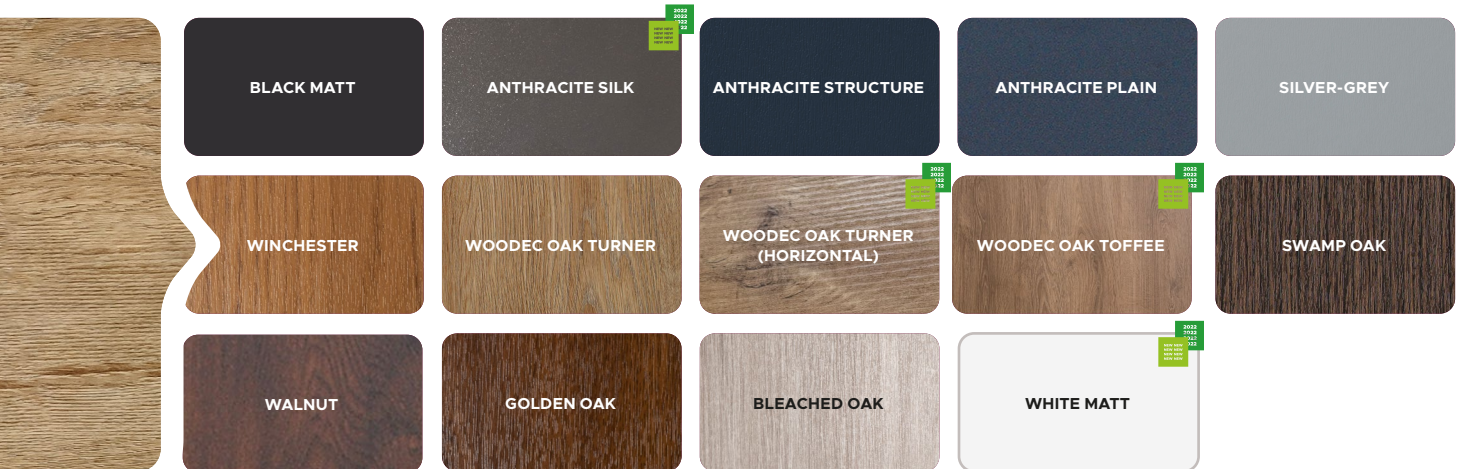

Cameleon doors are available in sizes (door leaf widths): 80N, 80, 90N, 90 and 100 (size 100 is available at an additional cost; it is also not available for the Termo Prestige Lux line). Cameleon NORMAL doors are equipped with the standard equipment of the NORMAL line, excluding upper lock. Cameleon PREMIUM doors are equipped with the standard equipment of the PREMIUM line. Cameleon OPTIMUM doors are equipped with the standard equipment of the OPTIMUM line. Doors with glazing are available only with INOX and BLACK decor. Cameleon TERMO PRESTIGE LUX doors are equipped with the standard equipment of the TERMO PRESTIGE LUX line. Doors with glazing are available only with INOX and BLACK decor. Future INOX collection is not available as painted doors. Cameleon Protect doors are equipped with the standard equipment of the Protect line.

COLORS

DUOKOLOR

DOOR LEAF FROM OUTSIDE, INSIDE OR BOTH SIDES IN TWO DIFFERENT COLORS. POSSIBILITY OF COMBINING CAMELEON AND NATURAL DECOR COLORS IN DIFFERENT VARIANTS.

BIKOLOR

LEAF AND FRAME IN VENEER OR PAINTED DIFFERENTLY OUTSIDE THAN INSIDE. ALL COLORS CAN BE COMBINED. YOU CAN NOW MATCH THE DOOR TO THE INSIDE OF YOUR HOME AS WELL AS TO THE STYLE OF THE BUILDING.

FutureINOX MIXKOLOR

THE FUSION OF DUOKOLOR FUTURE INOX MIXKOLOR. THE FUSION OF DUOKOLOR AND BIKOLOR IN THE COMBINATIONS YOU LOVE THE MOST. ALL COLORS CAN BE COMBINED. NOW YOU CAN ADJUST ENTRY DOORS EVEN MORE TO YOUR PREFERENCES.

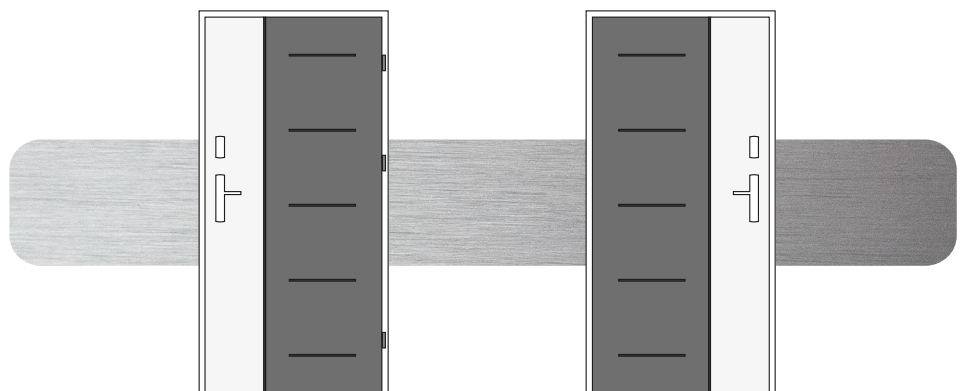
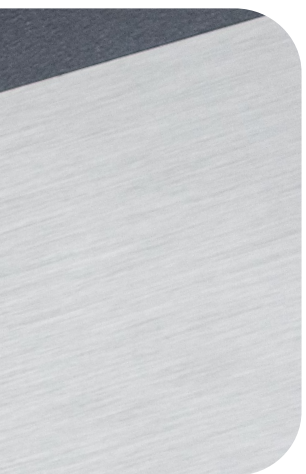
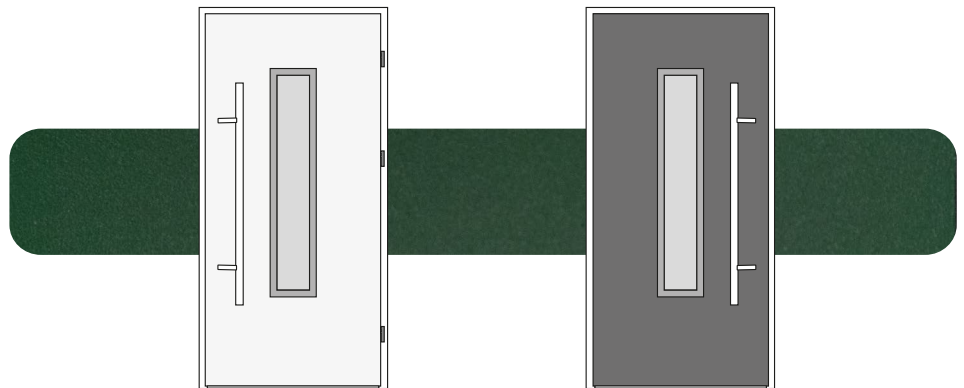
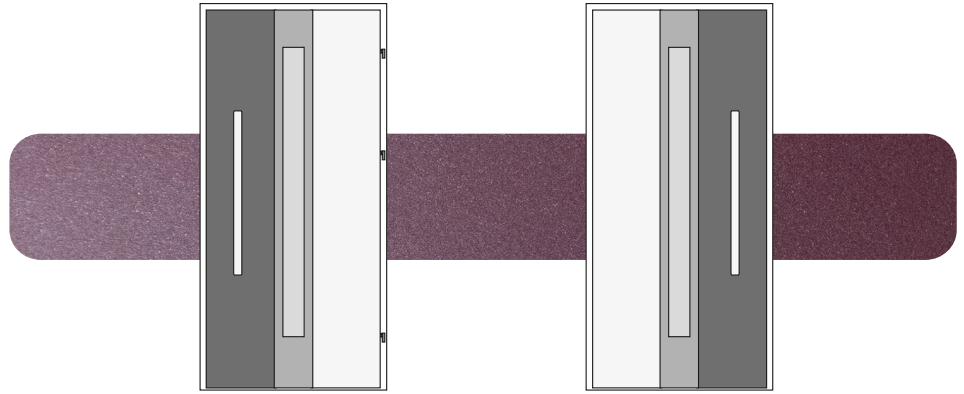
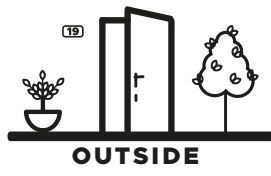





MODEL 52 / COLOR ANTHRACITE SILK / DOOR-BAR BETA



GLASS OPTIONS GLASS

Choose glazing for your entrance doors from the GLASS collection

GLASS DESIGN
BLACK



GLASS DESIGN
ONE-WAY MIRROR



GLASS FRONT
LACOBEL



GLASS LOFT
ONE-WAY MIRROR



GLASS LOFT
BLACK





Future GLASS

Choose glazing for your doors from the Future collection

**FUTURE INOX
STANDARD**



**FUTURE INOX
SATIN**



**FUTURE INOX
REFLEX BROWN**



**FUTURE INOX
ONE-WAY MIRROR**



★ The actual effect of the glazing shown depends on the pattern, color and light intensity..



GLASS **Classic Models**

Choose glazing for your doors from the Classic collection

**CLASSIC COLLECTION
STANDARD**



**CLASSIC COLLECTION
SATIN**



**CLASSIC COLLECTION
BLACK**



**CLASSIC COLLECTION
ONE-WAY MIRROR**



**MODEL 48
SKIP BLACK 3D**

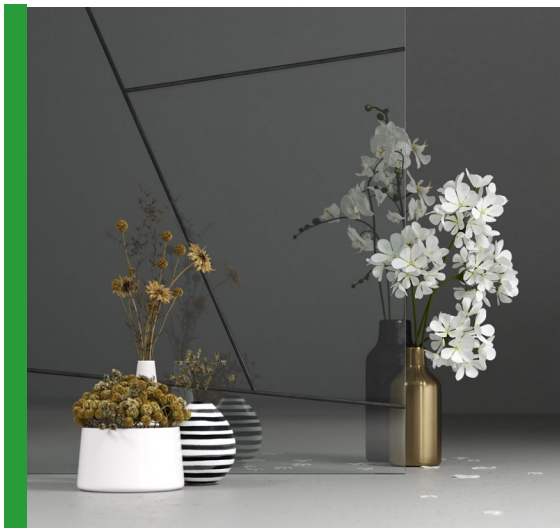

**MODEL 48
SKIP BLACK LACOBEL**

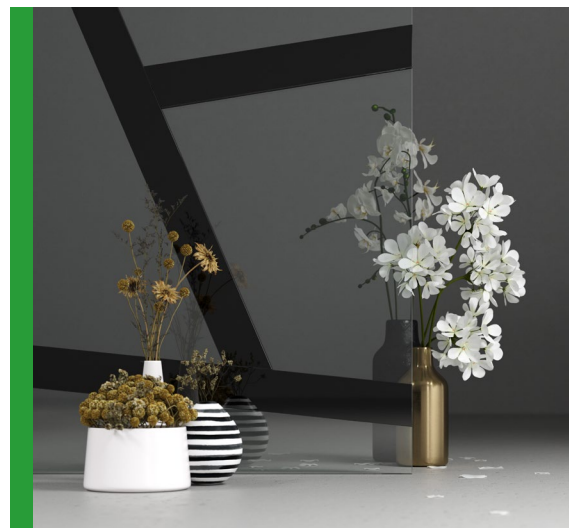

GLASS **Classic Models**

Choose glazing for your doors from the Classic collection

MODEL 48
SKIP MIRROR



MODEL 47
LACOBEL



MODEL 47
LACOBEL DOUBLE

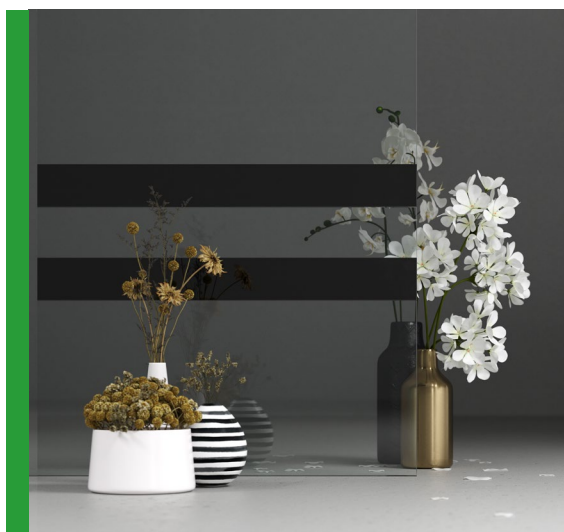

MODEL 47
MIRROR



MODEL 47
MIRROR DOUBLE



MODEL 47
SANDBLASTED



GLASS **Classic Models**

Choose glazing for your doors from the Classic collection

MODEL 47
SANDBLASTED DOUBLE



MODEL 47
PAINT BLACK



MODEL 47
PAINT BLACK DOUBLE





MG01



MG02



MG03



MG07

MY GLASS

Doors with individual graphics printed on tempered glass will emphasize the uniqueness of your home.



Do you want the door of your house to be unique?
Dreaming of a custom graphic on the door?

Do not limit yourself to our suggestions and contact us.

We will design and manufacture doors according to your individual project

Email the following address:
myglass@wikid.pl

A hand is shown holding a blue door bar against a dark door. The door has a vertical wood-grain panel on the right side. The background is dark and minimalist.

DOOR-BAR

SLIM SPACE

SLIM SPACE WALNUT

2022
2022
2022

NEW NEW
NEW NEW
NEW NEW
NEW NEW

AVAILABLE DESIGNS



AVAILABLE OPTIONS



SLIMSPACE

The Black and INOX door bar, 120 cm and 150 cm.
Possibility to combine the available options.
In the version with LED lighting, contains a twilight switch.

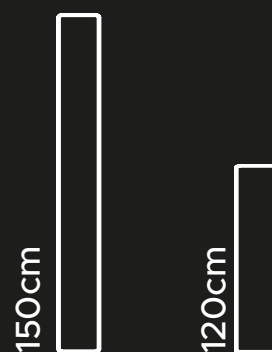

DOOR-BAR

SPACE



ANTHRACITE

AVAILABLE VERSIONS

SPACE WHITE LACOBEL



SPACE BLACK MARBLE BLACK



SPACE BLACK DECOR



SPACE WHITE COLOR



SPACE

BLACK or white door bar, sizes 90 cm and 50 cm.

Filling of the bars depending on version:

Decor - filling with any color of our veneer.

Deerstone - quartz agglomerate filling, colors: black marble, anatolian marble, wood-like.

Lacobel - filling with glossy black glass.

RAL - filling of a selected color from the RAL palette.

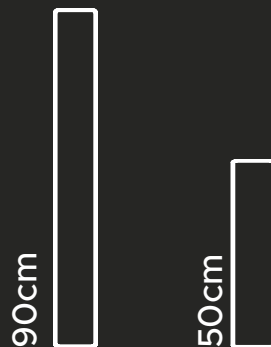

DOOR-BAR

TORO



TORO BLACK WITH FINGERPRINT READER

AVAILABLE VERSIONS

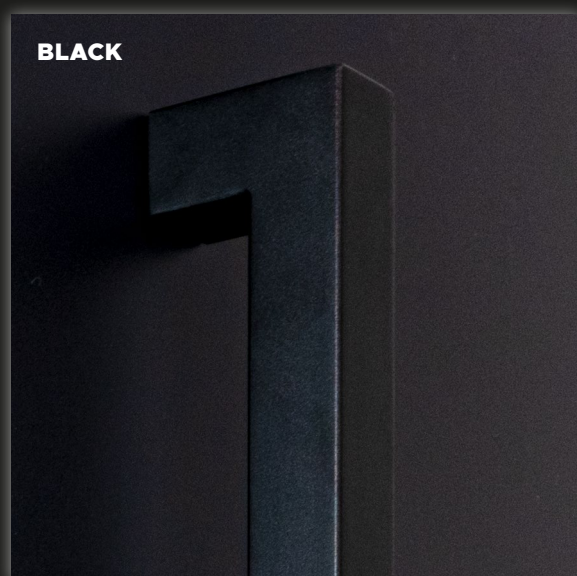

AVAILABLE OPTIONS



TORO

The Black and INOX door bar, 180 cm.
Possibility to combine the available options.
In the version with LED lighting, contains a twilight switch.



INOX



BLACK

180cm



DOOR-BAR

SLIM POCKET

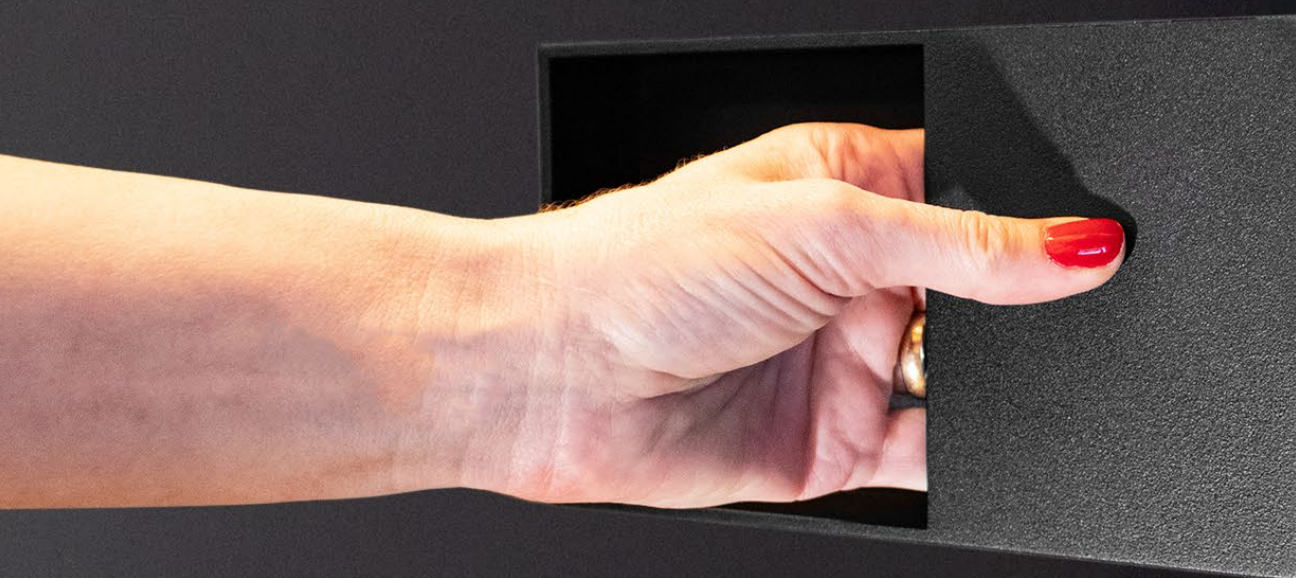

SLIM POCKET - BLACK

AVAILABLE VERSIONS

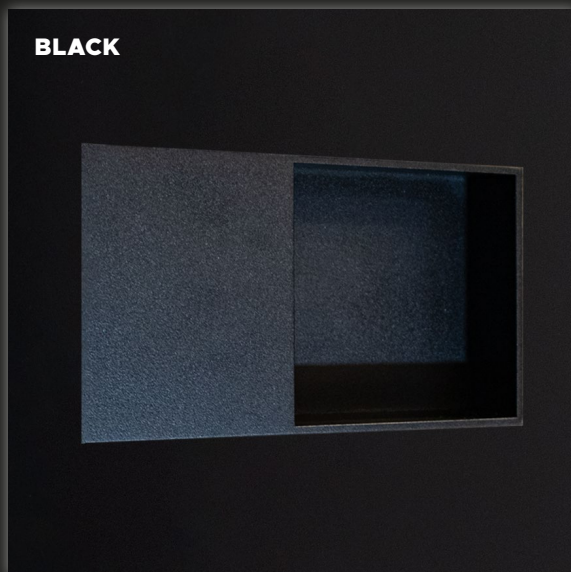

AVAILABLE OPTIONS

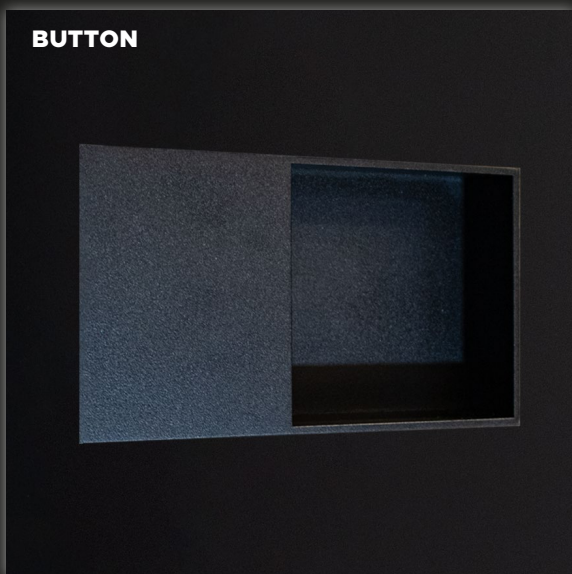

AVAILABLE DESIGNS



2022
2022
2022
2022

NEW NEW
NEW NEW
NEW NEW
NEW NEW

POCKET

Door bar flush with the door leaf.
Available sizes: 20 cm, 45 cm and 180 cm.
COLORS: INOX and Black



INOX



BLACK

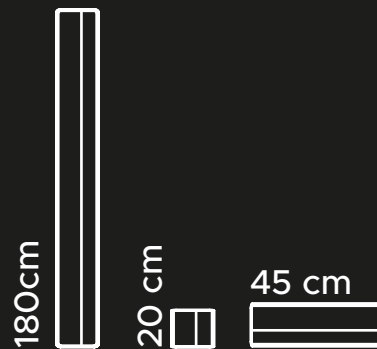

ALFA

Door bar

Inspirations: page 22, 91

Available sizes: 60 cm, 120 cm and 150 cm.

Colors: INOX and Black



Mount angle



INOX



BLACK



Button available for Termo Prestige Lux line



BETA

Door bar

Inspirations: page 14, 38

Available sizes: 120 cm and 150 cm.

Colors: INOX and Black



Mount angle



INOX



BLACK



GOLD



Button available for Termo Prestige Lux line



Fingerprint reader available



DUO BLACK

Door bar

Inspirations: page 49, 52

Available sizes (set): 2x50 cm

Colors: Black



POCKET

Door bar

Inspirations: page 10, 27

Door bar flush-mounted

Available sizes: 20 cm, 45 cm and 180 cm.

Colors: INOX and Black

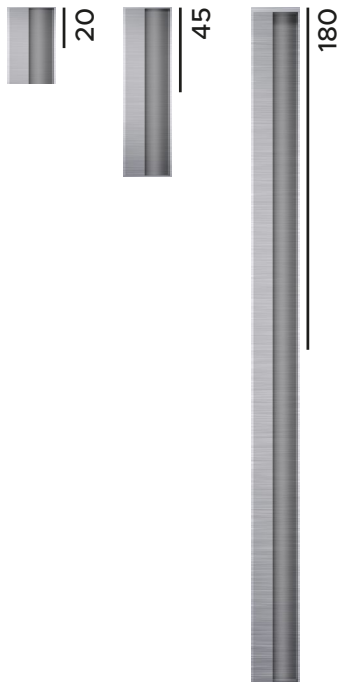

STRIPE

Door bar

Inspirations: page 16

Available sizes: 48 and 150 cm

Colors: INOX and Black



INOX



BLACK



48



150





MODEL 42 / COLOR SILVER-GREY / DOOR-BAR ALFA

LAVA

HANDLE



INOX



BLACK



Handles open doors all over the world.
In our offer, everyone will find an individual design suitable for the look of their door.



INOX



BLACK

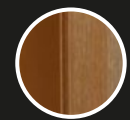

OLD
GOLD







BIOMETRIC SYSTEM

DESCRIPTION

Automatic door opening system - opening with a fingerprint. The set includes an Automatic lock and a power supply.



KEYPAD

DESCRIPTION

Automatic door opening system - opening by entering a code on the keypad. The set includes an Automatic lock and a power supply.

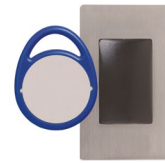

RFID SYSTEM

DESCRIPTION

Automatic door opening system - opening by an RFID token (2 pcs. included) or e.g. car remote control. The set includes an Automatic lock and a power supply.

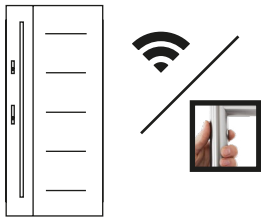

AUTOMATIC LOCK

DESCRIPTION

Automatic lock with remote controlled motor. The set includes an automatic lock and a power supply. Only for Termo Prestige Lux doors, fitted with an automatic locking mechanism. The element does not require the use of electric strikes.



ELECTRIC MOTOR LOCK

DESCRIPTION

Motorized lock with electric motor for external control.

The set includes a motorized lock and appropriate wiring. Available only for the Termo Prestige Lux and Alu Hybrid ranges.

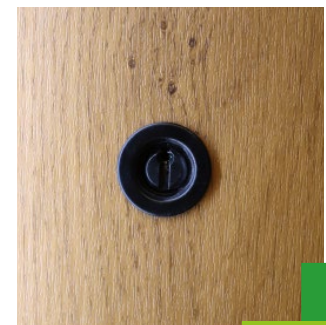

RING DOOR LOCK COVER

DESCRIPTION

Available only for the Termo Prestige Lux and Alu Hybrid doors.



TERMO FRAME

DESCRIPTION

Available for:
Premium
Optimum

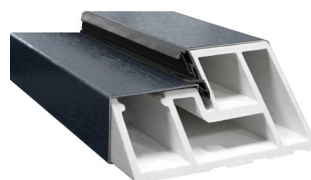

ALUMINUM-COMPOSITE FRAME

DESCRIPTION

Available for:
Premium
Optimum



DOOR-BAR DISABLING BUTTON

DESCRIPTION

INOX and Black



WISMART CONTROLLER

DESCRIPTION

New controller and app for smart door control. The smartphone can be used to control an automatic or motorized lock and additionally control the door lighting (threshold lighting or LED inlays) according to a planned schedule or nighttime setting in the app.

9 21



HOUSE NUMBERING

DESCRIPTION

Made of stainless steel from in INOX or Black. Height: 15cm. Includes a single number or a single letter with high-strength double-sided adhesive tape.

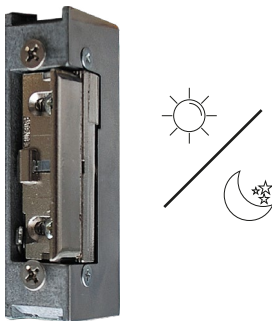

ELECTRIC STRIKE WITH MAGNETIC CONTACT SWITCH

DESCRIPTION

Optional versions with magnetic opened/closed sensor, day/night roll or memory.

Rated voltage: 8-12 V AC. Door closer needed when using roller function.



ELECTRONIC DOOR VISOR

DESCRIPTION

4" LCD digital screen, infrared camera. Records up to 50 photos when the doorbell is pressed.



DOOR VISOR STANDARD/PREMIUM

DESCRIPTION

Colors: gold, silver or black. Diameter: ø 30 / 46mm



MAGNETIC CONTACT SWITCH

DESCRIPTION

Opened/closed sensor. Colors: white, brown, anthracite

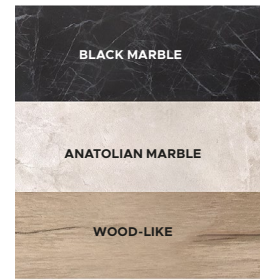

QUARTZ AGGLOMERATE DECORATIVE FRAME

DESCRIPTION

Colors: Black marble, Anatolian marble, Wood-like. By default applied on the outside only. The choice of the Deerstone frame limits the possibility of shortening the door to up to 100 mm.

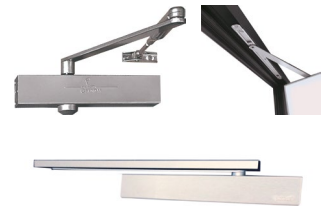

DOOR CLOSER

DESCRIPTION

Stainless steel door closer. Colors: black or silver.



ELECTRIC STRIKE POWER SUPPLY

DESCRIPTION

12V power supply mounted in an electrical box ø min. 70 mm and 24V installed in a pocket housing. Necessary for a door bar with a button or electric strike (connected to the power supply).



TERMO 90° JOINT

DESCRIPTION

A profile that can be easily connected to the Termo frame or the Termo sidelights, allowing connection at the 90° angle



DOOR CLOSER REINFORCEMENT

DESCRIPTION

Used to allow installation of a door closer later on.



ALU TECHNOLOGY

DESCRIPTION

The option is available for some classic door models with a Termo frame.

Allows to manufacture steel doors in aluminum technology. Cannot be used in Cameleon options.

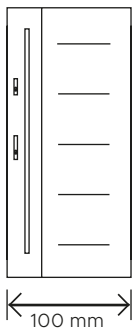

DOORS 100"

DESCRIPTION

Door leaf with size 100

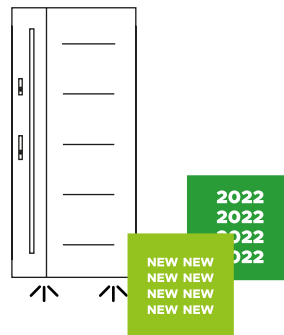

LED LIGHTING

DESCRIPTION

A subtle LED strip placed in the threshold makes the door even more beautiful and practical.

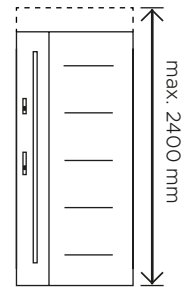

DOORS HIGHER THAN STANDARD

DESCRIPTION

Maximum height with frame (Hc) up to 2400 mm. Only available for doors with a Termo frame. It applies to single doors and doors with sidelights.



LETTERPLATE

DESCRIPTION

Color: INOX
Dimensions: 35x7,5 cm



CAT DOOR

DESCRIPTION

Transparent and silent flap with special seal and magnetic lock; has 4 modes to enter. Made of plastic resistant to various weather conditions.
Colors: white, gray



CLEANING AND POLISHING SPRAY

DESCRIPTION

For INOX stainless steel
Together with a microfiber cloth. Removes dust, grease and fingerprints. Preserves the surface, provides the proper protection, leaving a streak-free shine.
Capacity: 650ml.



Termo Sidelight

Sidelights are only available as a set with TERMO frame.

By using TERMO frames, it is possible to combine sidelights with single leaf doors and double doors. They consist of a TERMO aluminum profile with thermal break. Available in all colors. Each sidelight has triple glazing as standard. The sidelight set includes a mounting kit.

It is possible to make sidelights and toplights in non-standard sizes.

AVAILABLE OPTIONS

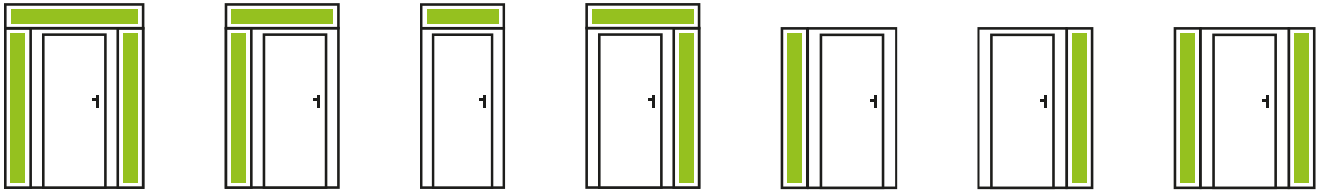

LED LIGHTING

DOOR-BAR

The delicate LED light illuminating the door bar is very practical and gives an amazing visual effect. Check which of our pull rods can be illuminated.

SIDELIGHT

Our sidelights can be equipped with the linear LED light matching the door models. The delicate horizontally arranged light mounted in the glazing will add individuality to your home.

THRESHOLD

The subtle light placed in the threshold makes the door even more beautiful and practical. Your doors keep looking great long after dusk.





WIKĘD Π²

3 YEAR WARRANTY

If you have decided to buy a Wikęd entrance door, extend the warranty period to 3 years.

Register your installed door via the QR code on the nameplate or do so via our website.

For more information, please visit our website and our professional showrooms.



Create the door of your dreams with our customizer.

We thank you for your confidence and the motivation for further development.

In this catalog of the entrance doors collection 2022, we have presented several new products and inspiring solutions, which constitute a small part of all our production capabilities.

You can be sure that in our offer you will find everything you need - from functional and minimalist basic products to innovative, modern designs and the most sophisticated doors.



Due to technical limitations of printing and glazing manufacturing technology, patterns and colors may vary from actual. Photos are for illustrative purposes only. The door embossing is shallow. Due to the technology used, the outline of structural elements around the perimeter of the door leaf may be visible. This mainly applies to dark colors and doors painted in the RAL palette. Do not install dark color doors in areas exposed to direct and prolonged sunlight. Doors installed as exterior entry doors in locations exposed to direct weather conditions (rain, wind, etc.) must be outward opening doors. A roof is required for doors installed as exterior entry doors.



MODEL 43 / HANDLE TAHOMA / COLOR WOODCOAK TURNER

Also in our offer:

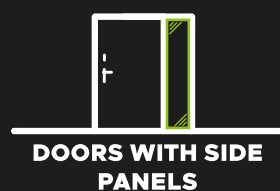

Wielki Las 19
84-242 Luzino
58 678 00 98
www.wiked.pl